

LP2981

Micropower 100 mA Ultra Low-Dropout Regulator

General Description

The LP2981 is a 100 mA, fixed-output voltage regulator designed specifically to meet the requirements of battery-powered applications.

Using an optimized VIP™ (Vertically Integrated PNP) process, the LP2981 delivers unequaled performance in all specifications critical to battery-powered designs:

Dropout Voltage. Typically 200 mV @ 100 mA load, and 7 mV @ 1 mA load.

Ground Pin Current. Typically 600 μ A @ 100 mA load, and 80 μ A @ 1 mA load.

Sleep Mode. Less than 1 μ A quiescent current when ON/OFF pin is pulled low.

Smallest Possible Size. SOT-23 and micro SMD packages use an absolute minimum board space.

Precision Output. 0.75% tolerance output voltages available (A grade).

Eleven voltage options, from 2.5V to 5.0V, are available as standard products.

Features

- Ultra low dropout voltage
- Output voltage accuracy 0.75% (A Grade)
- Guaranteed 100 mA output current
- Smallest possible size (SOT-23, micro SMD package)
- < 1 μ A quiescent current when shutdown
- Low ground pin current at all load currents
- High peak current capability (300 mA typical)
- Wide supply voltage range (16V max)
- Fast dynamic response to line and load
- Low Z_{OUT} over wide frequency range
- Overtemperature/overcurrent protection
- -40°C to $+125^{\circ}\text{C}$ junction temperature range

Applications

- Cellular Phone
- Palmtop/Laptop Computer
- Personal Digital Assistant (PDA)
- Camcorder, Personal Stereo, Camera

Block Diagram

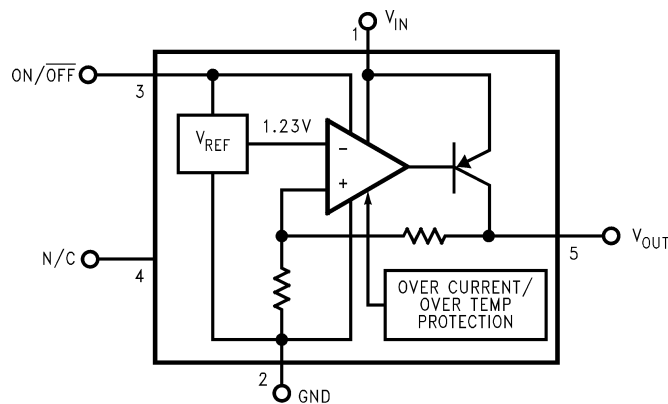

DS012506-1

Connection Diagrams

5-Lead Small Outline Package (M5)

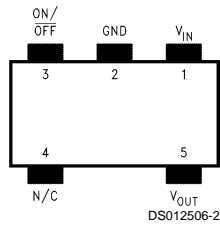

Top View

See NS Package Number MF05A
For ordering information see Table 1

micro SMD, 5 Bump Package (BPA05)

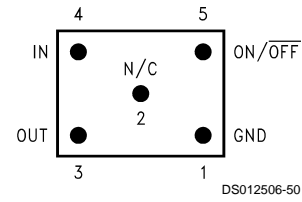

Bottom View

See NS Package Number BPA05

Ordering Information

TABLE 1. Package Marking and Order Information

| Output Voltage (V) | Grade | Order Information | Package Marking | Supplied as: |
|--|-------|-------------------|-----------------|-----------------------------|
| 5-Lead Small Outline Package (M5) | | | | |
| 2.5 | A | LP2981AIM5X-2.5 | L0CA | 3000 Units on Tape and Reel |
| 2.5 | A | LP2981AIM5-2.5 | L0CA | 1000 Units on Tape and Reel |
| 2.5 | STD | LP2981IM5X-2.5 | L0CB | 3000 Units on Tape and Reel |
| 2.5 | STD | LP2981IM5-2.5 | L0CB | 1000 Units on Tape and Reel |
| 2.7 | A | LP2981AIM5X-2.7 | L0DA | 3000 Units on Tape and Reel |
| 2.7 | A | LP2981AIM5-2.7 | L0DA | 1000 Units on Tape and Reel |
| 2.7 | STD | LP2981IM5X-2.7 | L0DB | 3000 Units on Tape and Reel |
| 2.7 | STD | LP2981IM5-2.7 | L0DB | 1000 Units on Tape and Reel |
| 2.8 | A | LP2981AIM5X-2.8 | L77A | 3000 Units on Tape and Reel |
| 2.8 | A | LP2981AIM5-2.8 | L77A | 1000 Units on Tape and Reel |
| 2.8 | STD | LP2981IM5X-2.8 | L77B | 3000 Units on Tape and Reel |
| 2.8 | STD | LP2981IM5-2.8 | L77B | 1000 Units on Tape and Reel |
| 2.9 | A | LP2981AIM5X-2.9 | L0VA | 3000 Units on Tape and Reel |
| 2.9 | A | LP2981AIM5-2.9 | L0VA | 1000 Units on Tape and Reel |
| 2.9 | STD | LP2981IM5X-2.9 | L0VB | 3000 Units on Tape and Reel |
| 2.9 | STD | LP2981IM5-2.9 | L0VB | 1000 Units on Tape and Reel |
| 3.0 | A | LP2981AIM5X-3.0 | L05A | 3000 Units on Tape and Reel |
| 3.0 | A | LP2981AIM5-3.0 | L05A | 1000 Units on Tape and Reel |
| 3.0 | STD | LP2981IM5X-3.0 | L05B | 3000 Units on Tape and Reel |
| 3.0 | STD | LP2981IM5-3.0 | L05B | 1000 Units on Tape and Reel |
| 3.1 | A | LP2981AIM5X-3.1 | L38A | 3000 Units on Tape and Reel |
| 3.1 | A | LP2981AIM5-3.1 | L38A | 1000 Units on Tape and Reel |
| 3.1 | STD | LP2981IM5X-3.1 | L38B | 3000 Units on Tape and Reel |
| 3.1 | STD | LP2981IM5-3.1 | L38B | 1000 Units on Tape and Reel |
| 3.2 | A | LP2981AIM5X-3.2 | L35A | 3000 Units on Tape and Reel |
| 3.2 | A | LP2981AIM5-3.2 | L35A | 1000 Units on Tape and Reel |
| 3.2 | STD | LP2981IM5X-3.2 | L35B | 3000 Units on Tape and Reel |
| 3.2 | STD | LP2981IM5-3.2 | L35B | 1000 Units on Tape and Reel |
| 3.3 | A | LP2981AIM5X-3.3 | L04A | 3000 Units on Tape and Reel |
| 3.3 | A | LP2981AIM5-3.3 | L04A | 1000 Units on Tape and Reel |
| 3.3 | STD | LP2981IM5X-3.3 | L04B | 3000 Units on Tape and Reel |
| 3.3 | STD | LP2981IM5-3.3 | L04B | 1000 Units on Tape and Reel |

Ordering Information (Continued)**TABLE 1. Package Marking and Order Information** (Continued)

| Output Voltage (V) | Grade | Order Information | Package Marking | Supplied as: |
|--|-------|-------------------|-----------------|-----------------------------|
| 5-Lead Small Outline Package (M5) | | | | |
| 3.6 | A | LP2981AIM5X-3.6 | LOJA | 3000 Units on Tape and Reel |
| 3.6 | A | LP2981AIM5-3.6 | LOJA | 1000 Units on Tape and Reel |
| 3.6 | STD | LP2981IM5X-3.6 | LOJB | 3000 Units on Tape and Reel |
| 3.6 | STD | LP2981IM5-3.6 | LOJB | 1000 Units on Tape and Reel |
| 3.8 | A | LP2981AIM5X-3.8 | L36A | 3000 Units on Tape and Reel |
| 3.8 | A | LP2981AIM5-3.8 | L36A | 1000 Units on Tape and Reel |
| 3.8 | STD | LP2981IM5X-3.8 | L36B | 3000 Units on Tape and Reel |
| 3.8 | STD | LP2981IM5-3.8 | L36B | 1000 Units on Tape and Reel |
| 4.0 | A | LP2981AIM5X-4.0 | LOZA | 3000 Units on Tape and Reel |
| 4.0 | A | LP2981AIM5-4.0 | LOZA | 1000 Units on Tape and Reel |
| 4.0 | STD | LP2981IM5X-4.0 | LOZB | 3000 Units on Tape and Reel |
| 4.0 | STD | LP2981IM5-4.0 | LOZB | 1000 Units on Tape and Reel |
| 4.7 | A | LP2981AIM5X-4.7 | LOGA | 3000 Units on Tape and Reel |
| 4.7 | A | LP2981AIM5-4.7 | LOGA | 1000 Units on Tape and Reel |
| 4.7 | STD | LP2981IM5X-4.7 | LOGB | 3000 Units on Tape and Reel |
| 4.7 | STD | LP2981IM5-4.7 | LOGB | 1000 Units on Tape and Reel |
| 5.0 | A | LP2981AIM5X-5.0 | L03A | 3000 Units on Tape and Reel |
| 5.0 | A | LP2981AIM5-5.0 | L03A | 1000 Units on Tape and Reel |
| 5.0 | STD | LP2981IM5X-5.0 | L03B | 3000 Units on Tape and Reel |
| 5.0 | STD | LP2981IM5-5.0 | L03B | 1000 Units on Tape and Reel |
| micro SMD, 5 Bump Package (BPA05) | | | | |
| 2.5 | A | LP2981AIBP-2.5 | | 250 Units on Tape and Reel |
| 2.5 | A | LP2981AIBPX-2.5 | | 3000 Units on Tape and Reel |
| 2.5 | STD | LP2981IBP-2.5 | | 250 Units on Tape and Reel |
| 2.5 | STD | LP2981IBPX-2.5 | | 3000 Units on Tape and Reel |
| 3.2 | A | LP2981AIBP-3.2 | | 250 Units on Tape and Reel |
| 3.2 | A | LP2981AIBPX-3.2 | | 3000 Units on Tape and Reel |
| 3.2 | STD | LP2981IBP-3.2 | | 250 Units on Tape and Reel |
| 3.2 | STD | LP2981IBPX-3.2 | | 3000 Units on Tape and Reel |
| 3.3 | A | LP2981AIBP-3.3 | | 250 Units on Tape and Reel |
| 3.3 | A | LP2981AIBPX-3.3 | | 3000 Units on Tape and Reel |
| 3.3 | STD | LP2981IBP-3.3 | | 250 Units on Tape and Reel |
| 3.3 | STD | LP2981IBPX-3.3 | | 3000 Units on Tape and Reel |

Absolute Maximum Ratings (Note 1)

If Military/Aerospace specified devices are required, please contact the National Semiconductor Sales Office/Distributors for availability and specifications.

| | |
|--------------------------------------|-----------------|
| Storage Temperature Range | -65°C to +150°C |
| Operating Junction Temperature Range | -40°C to +125°C |
| Lead Temperature (Soldering, 5 sec.) | 260°C |
| ESD Rating (Note 2) | 2 kV |

Power Dissipation (Note 3)

| | | |
|---|-------------------------|--------------------|
| Input Supply Voltage (Survival) | -0.3V to +16V | Internally Limited |
| Input Supply Voltage (Operating) | 2.1V to +16V | |
| Shutdown Input Voltage (Survival) | -0.3V to +16V | |
| Output Voltage (Survival, (Note 4)) | -0.3V to +9V | |
| I _{OUT} (Survival) | Short Circuit Protected | |
| Input-Output Voltage (Survival, (Note 5)) | -0.3V to +16V | |

Electrical Characteristics

Limits in standard typeface are for T_J = 25°C, and limits in **boldface type** apply over the full operating temperature range. Unless otherwise specified: V_{IN} = V_{O(NOM)} + 1V, C_{IN} = 1 μF, I_L = 1 mA, C_{OUT} = 4.7 μF, V_{ON/OFF} = 2V.

| Symbol | Parameter | Conditions | Typ | LP2981AI-XX (Note 6) | | LP2981I-XX (Note 6) | | Units |
|--|--------------------------------|---|-------------|-------------------------|-----------------------|------------------------|-----------------------|-------------------|
| | | | | Min | Max | Min | Max | |
| ΔV _O | Output Voltage Tolerance | I _L = 1 mA | | -0.75 | 0.75 | -1.25 | 1.25 | %V _{NOM} |
| | | 1 mA < I _L < 100 mA | | -1.0 -2.5 | 1.0 2.5 | -2.0 -3.5 | 2.0 3.5 | |
| $\frac{\Delta V_O}{\Delta V_{IN}}$ | Output Voltage Line Regulation | V _{O(NOM)} + 1V ≤ V _{IN} ≤ 16V | 0.007 | | 0.014 0.032 | | 0.014 0.032 | %/V |
| V _{IN} -V _O | Dropout Voltage (Note 7) | I _L = 0 | 1 | | 3 5 | | 3 5 | mV |
| | | I _L = 1 mA | 7 | | 10 15 | | 10 15 | |
| | | I _L = 25 mA | 70 | | 100 150 | | 100 150 | |
| | | I _L = 100 mA | 200 | | 250 375 | | 250 375 | |
| I _{GND} | Ground Pin Current | I _L = 0 | 65 | | 95 125 | | 95 125 | μA |
| | | I _L = 1 mA | 80 | | 110 170 | | 110 170 | |
| | | I _L = 25 mA | 200 | | 300 550 | | 300 550 | |
| | | I _L = 100 mA | 600 | | 800 1500 | | 800 1500 | |
| | | V _{ON/OFF} < 0.3V | 0.01 | | 0.8 | | 0.8 | |
| | | V _{ON/OFF} < 0.15V | 0.05 | | 2 | | 2 | |
| V _{ON/OFF} | ON/OFF Input Voltage (Note 8) | High = O/P ON | 1.4 | 1.6 | | 1.6 | | V |
| | | LOW = O/P OFF | 0.50 | | 0.15 | | 0.15 | |
| I _{ON/OFF} | ON/OFF Input Current | V _{ON/OFF} = 0 | 0.01 | | -1 | | -1 | μA |
| | | V _{ON/OFF} = 5V | 5 | | 15 | | 15 | |
| I _{O(PK)} | Peak Output Current | V _{OUT} ≥ V _{O(NOM)} - 5% | 400 | 150 | | 150 | | mA |
| e _n | Output Noise Voltage (RMS) | BW = 300 Hz-50 kHz, C _{OUT} = 10 μF | 160 | | | | | μV |
| $\frac{\Delta V_{OUT}}{\Delta V_{IN}}$ | Ripple Rejection | f = 1 kHz C _{OUT} = 10 μF | 63 | | | | | dB |
| I _{O(MAX)} | Short Circuit Current | R _L = 0 (Steady State) (Note 9) | 150 | | | | | mA |

Electrical Characteristics (Continued)

Note 1: Absolute maximum ratings indicate limits beyond which damage to the component may occur. Electrical specifications do not apply when operating the device outside of its rated operating conditions.

Note 2: The ESD rating of pins 3 and 4 is 1 kV.

Note 3: The maximum allowable power dissipation is a function of the maximum junction temperature, $T_{J(MAX)}$, the junction-to-ambient thermal resistance, θ_{JA} , and the ambient temperature, T_A . The maximum allowable power dissipation at any ambient temperature is calculated using:

$$P (MAX) = \frac{T_{J(MAX)} - T_A}{\theta_{JA}}$$

The value of θ_{JA} for the SOT-23 package is 220°C/W and the micro SMD package is 320°C/W. Exceeding the maximum allowable power dissipation will cause excessive die temperature, and the regulator will go into thermal shutdown.

Note 4: If used in a dual-supply system where the regulator load is returned to a negative supply, the LP2981 output must be diode-clamped to ground.

Note 5: The output PNP structure contains a diode between the V_{IN} and V_{OUT} terminals that is normally reverse-biased. Reversing the polarity from V_{IN} to V_{OUT} will turn on this diode (see Application Hints).

Note 6: Limits are 100% production tested at 25°C. Limits over the operating temperature range are guaranteed through correlation using Statistical Quality Control (SQC) methods. The limits are used to calculate National's Average Outgoing Quality Level (AOQL).

Note 7: Dropout voltage is defined as the input to output differential at which the output voltage drops 100 mV below the value measured with a 1V differential.

Note 8: The ON/OFF inputs must be properly driven to prevent misoperation. For details, refer to Application Hints.

Note 9: See Typical Performance Characteristics curves.

Basic Application Circuit

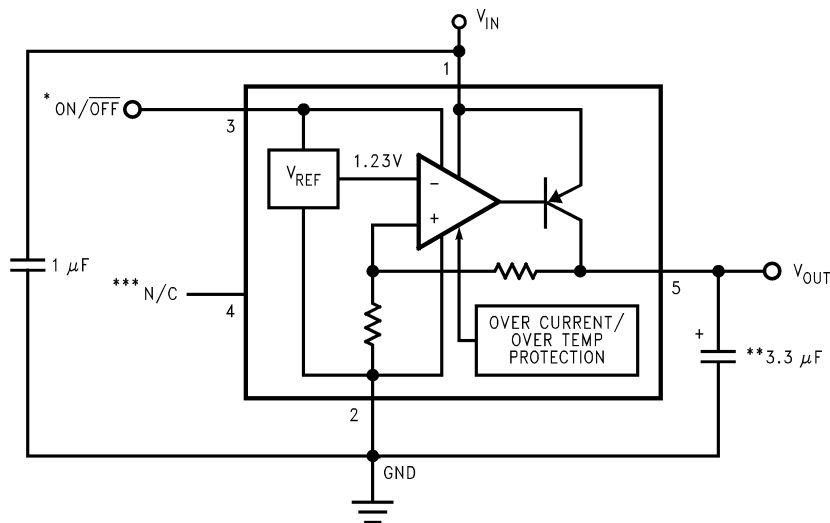

DS012506-4

*ON/OFF input must be actively terminated. Tie to V_{IN} if this function is not to be used.

**Minimum Output Capacitance is shown to insure stability over full load current range. More capacitance provides superior dynamic performance and additional stability margin (see Application Hints).

***Do not make connections to this pin.

Typical Performance Characteristics Unless otherwise specified: $T_A = 25^\circ\text{C}$, $V_{IN} = V_{O(NOM)} + 1\text{V}$, $C_{OUT} = 4.7\ \mu\text{F}$, $C_{IN} = 1\ \mu\text{F}$ all voltage options, ON/OFF pin tied to V_{IN} .

Output Voltage vs Temperature

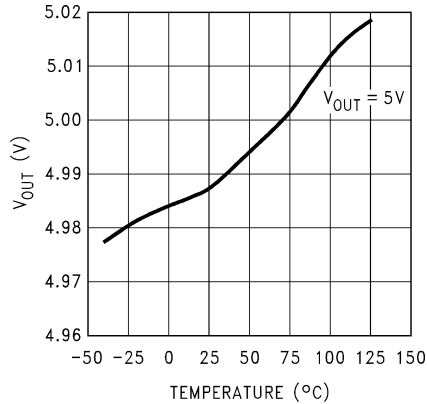

Output Voltage vs Temperature

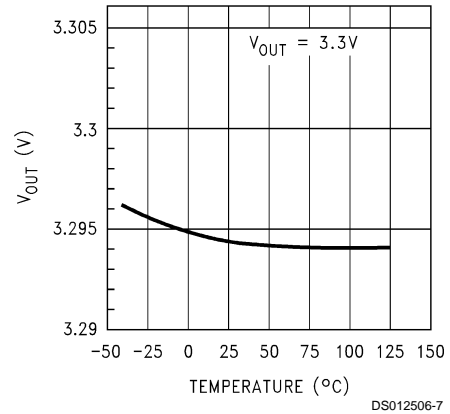

Output Voltage vs Temperature

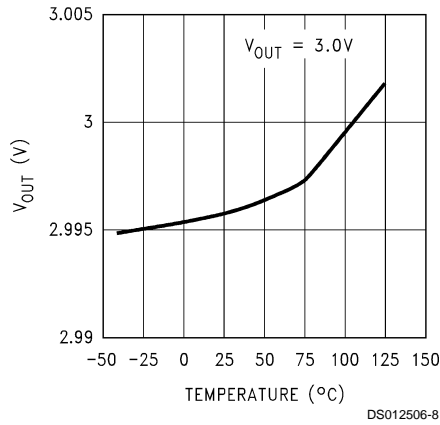

Dropout Characteristics

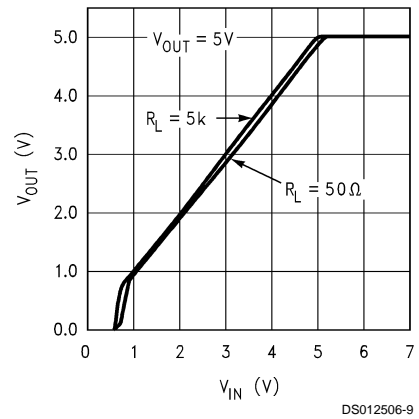

Dropout Characteristics

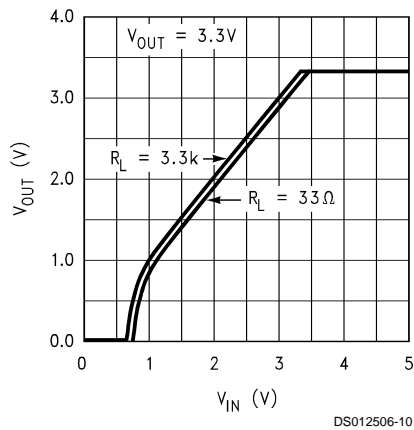

Dropout Characteristics

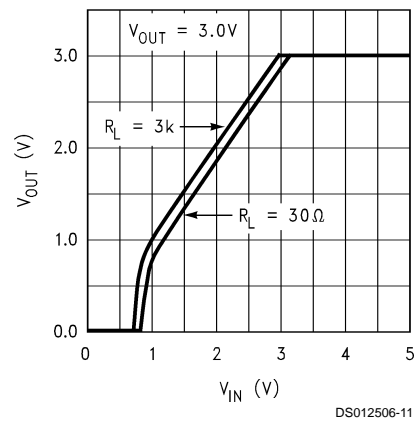

Typical Performance Characteristics

Unless otherwise specified: $T_A = 25^\circ\text{C}$, $V_{IN} = V_{O(NOM)} + 1\text{V}$, $C_{OUT} = 4.7\ \mu\text{F}$, $C_{IN} = 1\ \mu\text{F}$ all voltage options, ON/OFF pin tied to V_{IN} . (Continued)

Dropout Voltage vs Temperature

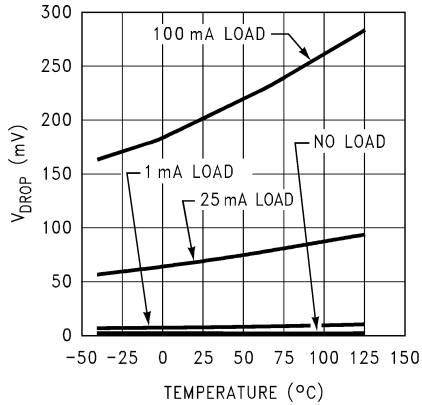

DS012506-12

Dropout Voltage vs Load Current

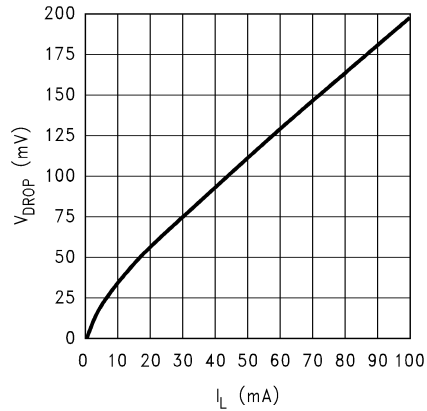

DS012506-13

Ground Pin Current vs Temperature

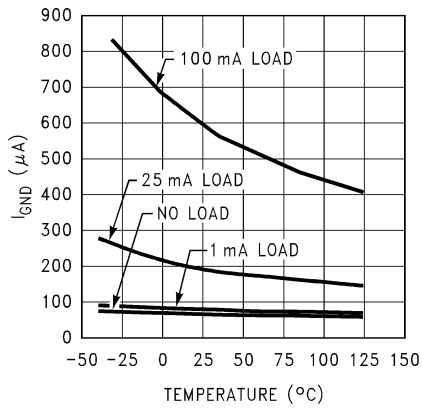

DS012506-14

Ground Pin Current vs Load Current

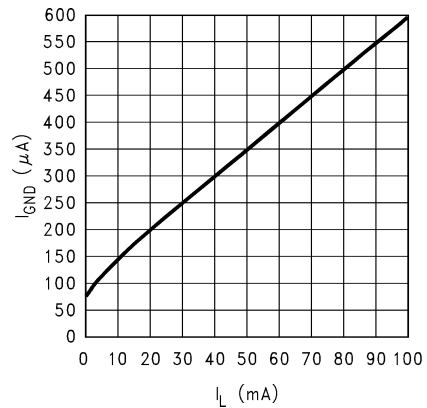

DS012506-15

Input Current vs V_{IN}

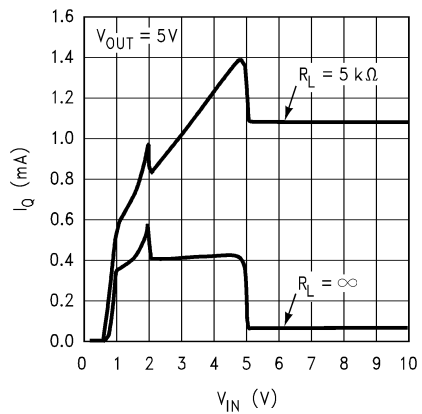

DS012506-16

Input Current vs V_{IN}

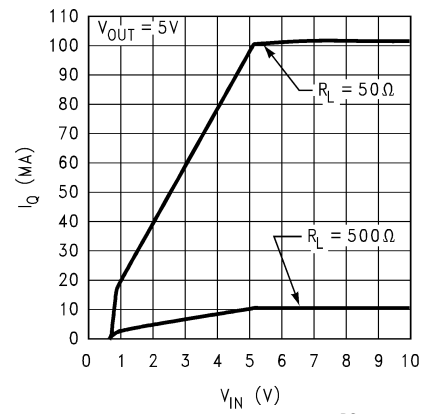

DS012506-17

Typical Performance Characteristics Unless otherwise specified: $T_A = 25^\circ\text{C}$, $V_{IN} = V_{O(NOM)} + 1\text{V}$, $C_{OUT} = 4.7\ \mu\text{F}$, $C_{IN} = 1\ \mu\text{F}$ all voltage options, ON/OFF pin tied to V_{IN} . (Continued)

Line Transient Response

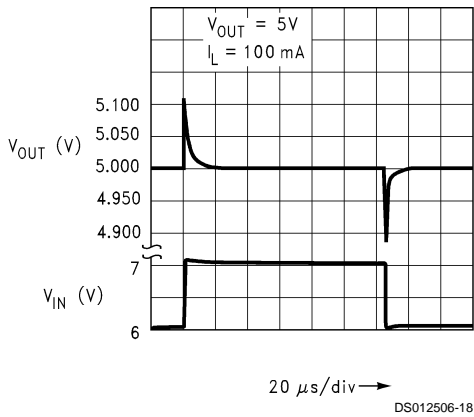

Line Transient Response

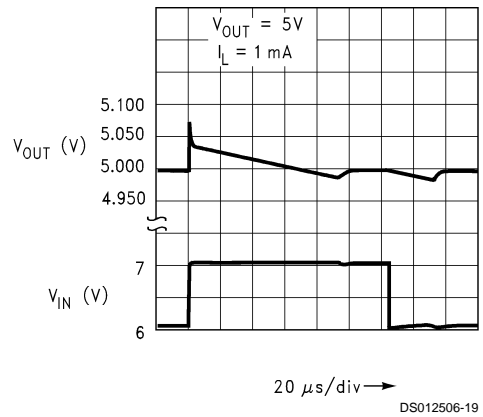

Load Transient Response

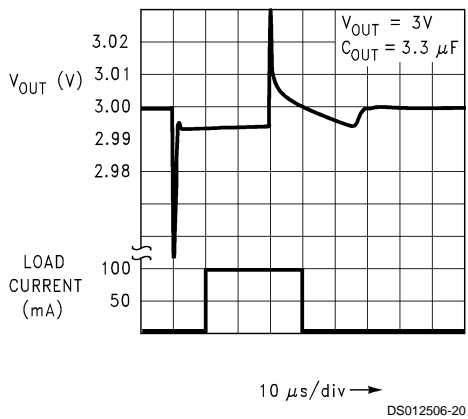

Load Transient Response

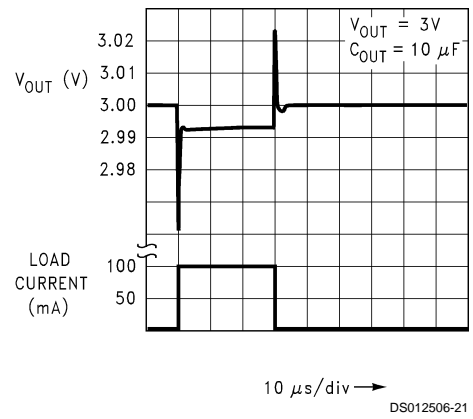

Load Transient Response

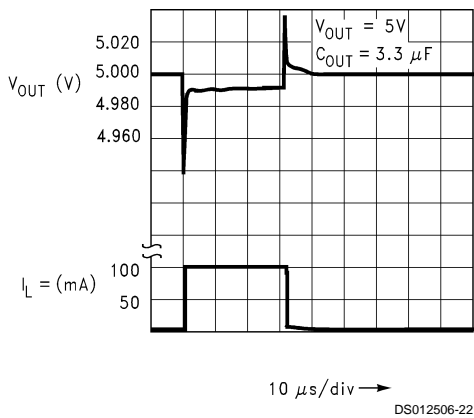

Load Transient Response

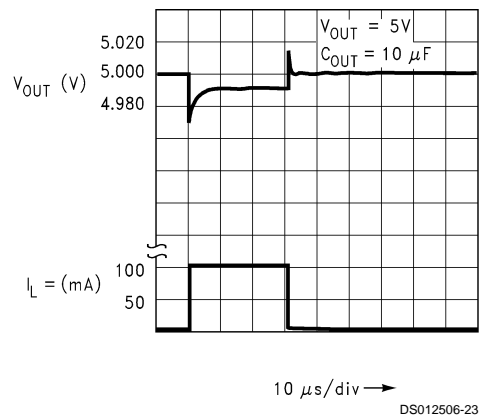

Typical Performance Characteristics Unless otherwise specified: $T_A = 25^\circ\text{C}$, $V_{IN} = V_{O(NOM)} + 1\text{V}$, $C_{OUT} = 4.7\ \mu\text{F}$, $C_{IN} = 1\ \mu\text{F}$ all voltage options, ON/OFF pin tied to V_{IN} . (Continued)

Short Circuit Current

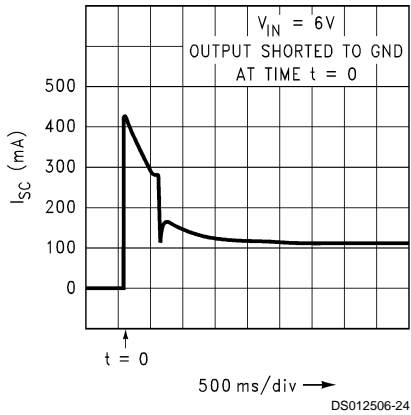

Instantaneous Short Circuit Current vs Temperature

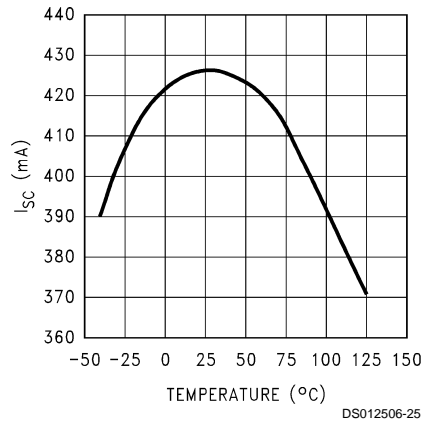

Short Circuit Current

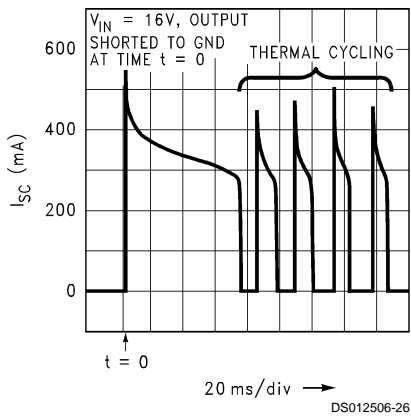

Instantaneous Short Circuit Current vs Output Voltage

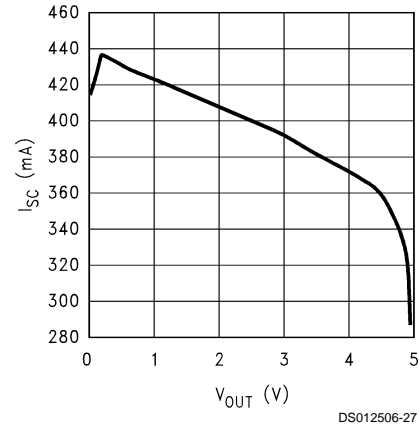

Output Impedance vs Frequency

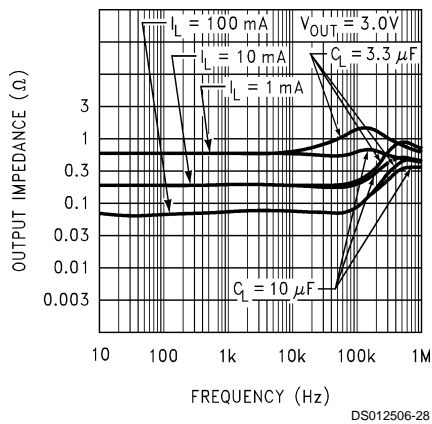

Ripple Rejection

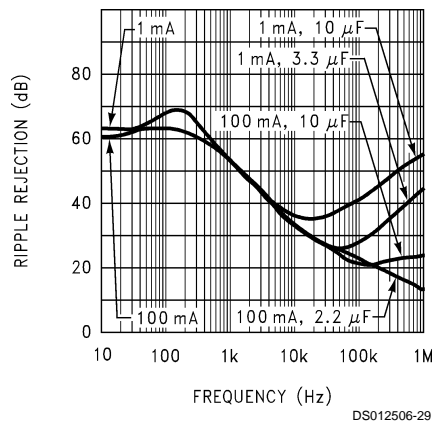

Typical Performance Characteristics Unless otherwise specified: $T_A = 25^\circ\text{C}$, $V_{IN} = V_{O(NOM)} + 1\text{V}$, $C_{OUT} = 4.7\ \mu\text{F}$, $C_{IN} = 1\ \mu\text{F}$ all voltage options, ON/OFF pin tied to V_{IN} . (Continued)

Output Noise Density

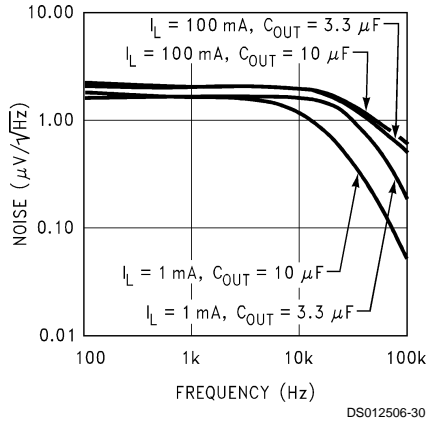

Output Impedance vs Frequency

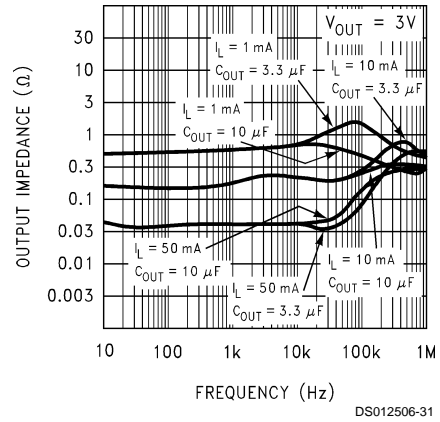

Input to Output Leakage vs Temperature

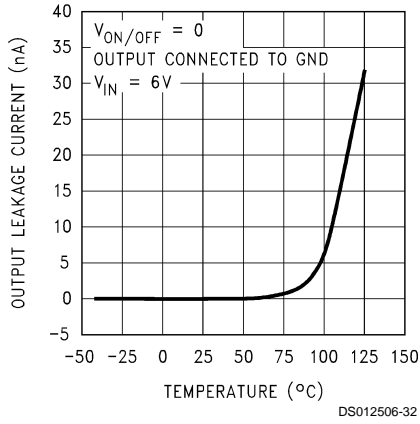

Output Reverse Leakage vs Temperature

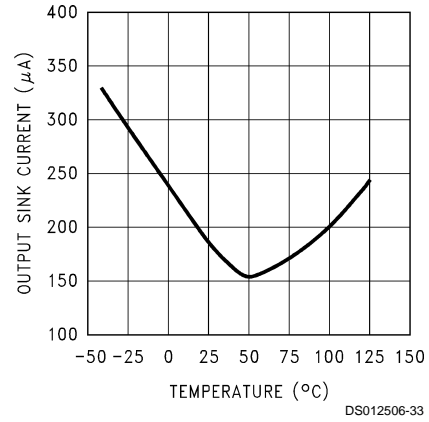

Turn-On Waveform

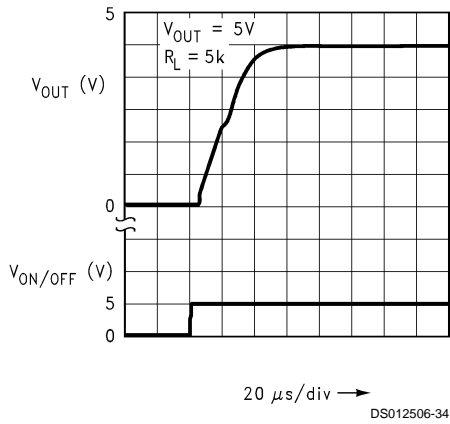

Turn-Off Waveform

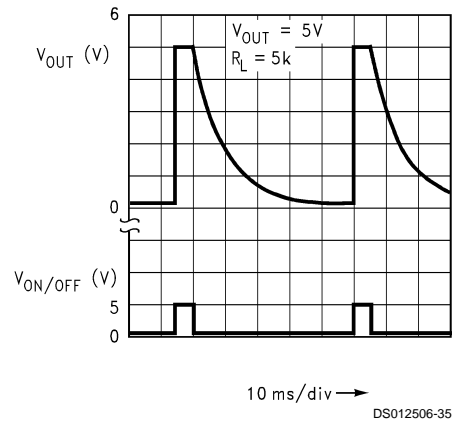

Typical Performance Characteristics Unless otherwise specified: $T_A = 25^\circ\text{C}$, $V_{IN} = V_{O(NOM)} + 1\text{V}$, $C_{OUT} = 4.7\ \mu\text{F}$, $C_{IN} = 1\ \mu\text{F}$ all voltage options, ON/OFF pin tied to V_{IN} . (Continued)

ON/OFF Pin Current vs $V_{ON/OFF}$

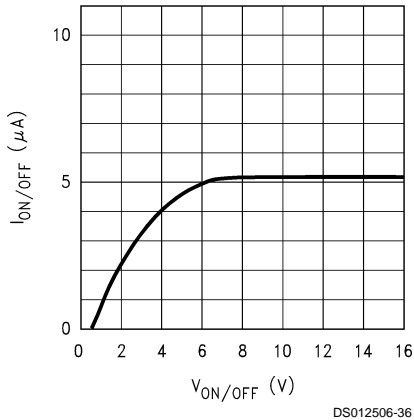

ON/OFF Threshold vs Temperature

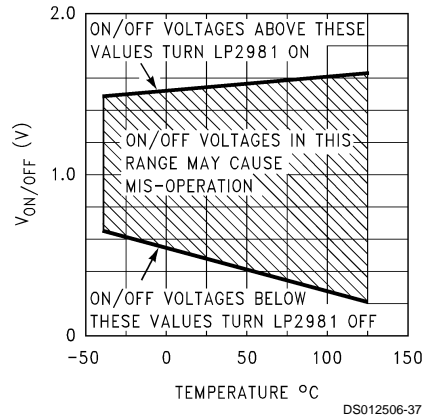

Application Hints

EXTERNAL CAPACITORS

Like any low-dropout regulator, the external capacitors used with the LP2981 must be carefully selected to assure regulator loop stability.

INPUT CAPACITOR: An input capacitor whose value is $\geq 1\ \mu\text{F}$ is required with the LP2981 (amount of capacitance can be increased without limit).

This capacitor must be located a distance of not more than 0.5" from the input pin of the LP2981 and returned to a clean analog ground. Any good quality ceramic or tantalum can be used for this capacitor.

OUTPUT CAPACITOR: The output capacitor must meet both the requirement for minimum amount of capacitance and E.S.R. (equivalent series resistance) value. Curves are provided which show the allowable ESR range as a function of load current for various output voltages and capacitor values (refer to Figures 1, 2, 3, 4).

IMPORTANT: The output capacitor must maintain its ESR in the stable region over the full operating temperature range to assure stability. Also, capacitor tolerance and variation with temperature must be considered to assure the minimum amount of capacitance is provided at all times.

This capacitor should be located not more than 0.5" from the output pin of the LP2981 and returned to a clean analog ground.

CAPACITOR CHARACTERISTICS

TANTALUM: Tantalum capacitors are the best choice for use with the LP2981. Most good quality tantalums can be used with the LP2981, but check the manufacturer's data sheet to be sure the ESR is in range.

It is important to remember that ESR increases at lower temperatures and a capacitor that is near the upper limit for stability at room temperature can cause instability when it gets cold.

In applications which must operate at very low temperatures, it may be necessary to parallel the output tantalum capacitor with a ceramic capacitor to prevent the ESR from going up too high (see next section for important information on ceramic capacitors).

CERAMIC: Ceramic capacitors are not recommended for use at the output of the LP2981. This is because the ESR of a ceramic can be low enough to go below the minimum stable value for the LP2981. A 2.2 μF ceramic was measured and found to have an ESR of about 15 m Ω , which is low enough to cause oscillations.

If a ceramic capacitor is used on the output, a 1 Ω resistor should be placed in series with the capacitor.

ALUMINUM: Because of large physical size, aluminum electrolytics are not typically used with the LP2981. They must meet the same ESR requirements over the operating temperature range, more difficult because of their steep increase at cold temperature.

An aluminum electrolytic can exhibit an ESR increase of as much as 50X when going from 20 $^\circ\text{C}$ to -40 $^\circ\text{C}$. Also, some aluminum electrolytics are not operational below -25 $^\circ\text{C}$ because the electrolyte can freeze.

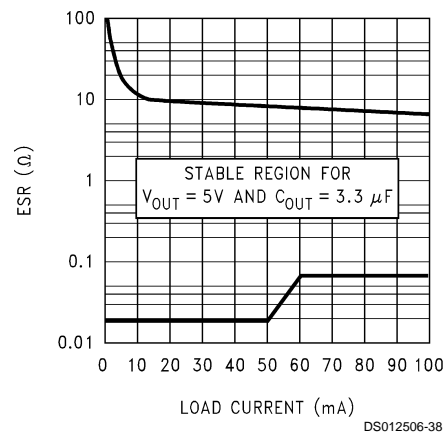

FIGURE 1. 5V/3.3 μF ESR Curves

Application Hints (Continued)

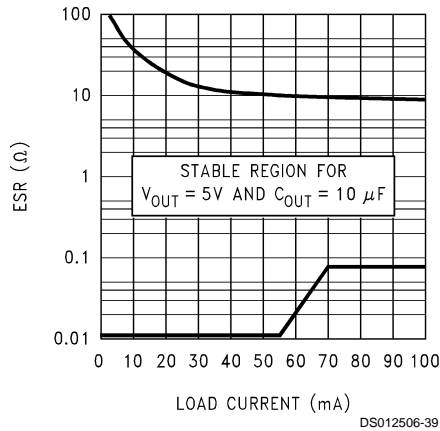

FIGURE 2. 5V/10 μF ESR Curves

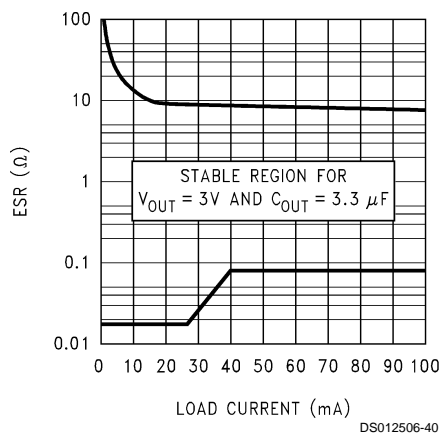

FIGURE 3. 3V/3.3 μF ESR Curves

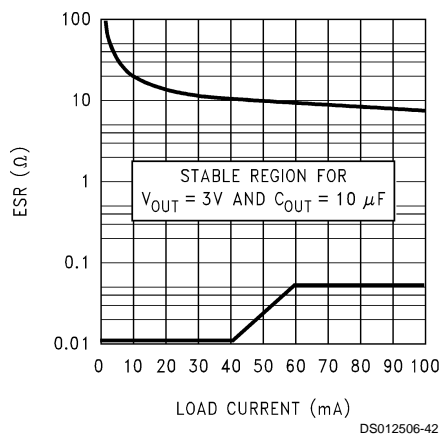
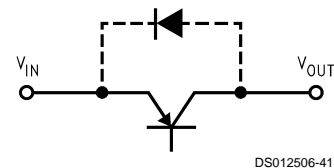

FIGURE 4. 3V/10 μF ESR Curves

REVERSE CURRENT PATH

The power transistor used in the LP2981 has an inherent diode connected between the regulator input and output (see below).



If the output is forced above the input by more than a V_{BE} , this diode will become forward biased and current will flow from the V_{OUT} terminal to V_{IN} .

This current must be limited to $< 100 \text{ mA}$ to prevent damage to the part.

The internal diode can also be turned on by abruptly stepping the input voltage to a value below the output voltage.

To prevent regulator mis-operation, a Schottky diode should be used in any application where input/output voltage conditions can cause the internal diode to be turned on (see below).

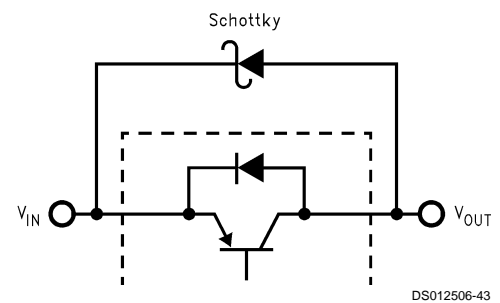

As shown, the Schottky diode is connected in parallel with the internal parasitic diode and prevents it from being turned on by limiting the voltage drop across it to about 0.3V.

ON/OFF INPUT OPERATION

The LP2981 is shut off by pulling the ON/OFF input low, and turned on by driving the input high. If this feature is not to be used, the ON/OFF input should be tied to V_{IN} to keep the regulator on at all times (the ON/OFF input must **not** be left floating).

To ensure proper operation, the signal source used to drive the ON/OFF input must be able to swing above and below the specified turn-on/turn-off voltage thresholds which guarantee an ON or OFF state (see Electrical Characteristics).

The ON/OFF signal may come from either a totem-pole output, or an open-collector output with pull-up resistor to the LP2981 input voltage or another logic supply. The high-level voltage may exceed the LP2981 input voltage, but must remain within the Absolute Maximum Ratings for the ON/OFF pin.

It is also important that the turn-on/turn-off voltage signals applied to the ON/OFF input have a slew rate which is greater than $40 \text{ mV}/\mu\text{s}$.

Important: the regulator shutdown function will operate incorrectly if a slow-moving signal is applied to the ON/OFF input.

Micro SMD Mounting

The micro SMD package requires specific mounting techniques which are detailed in National Semiconductor Application Note # 1112. Referring to the section **Surface Mount Technology (SMT) Assembly Considerations**, it should be noted that the pad style which must be used with the 5-pin package is the NSMD (non-solder mask defined) type.

Application Hints (Continued)

For best results during assembly, alignment ordinals on the PC board may be used to facilitate placement of the micro SMD device.

Micro SMD Light Sensitivity

Exposing the micro SMD device to direct sunlight will cause misoperation of the device. Light sources such as Halogen lamps can also affect electrical performance if brought near to the device.

The wavelengths which have the most detrimental effect are reds and infra-reds, which means that the fluorescent lighting used inside most buildings has very little effect on performance. A micro SMD test board was brought to within 1 cm of a fluorescent desk lamp and the effect on the regulated output voltage was negligible, showing a deviation of less than 0.1% from nominal.

Physical Dimensions inches (millimeters) unless otherwise noted

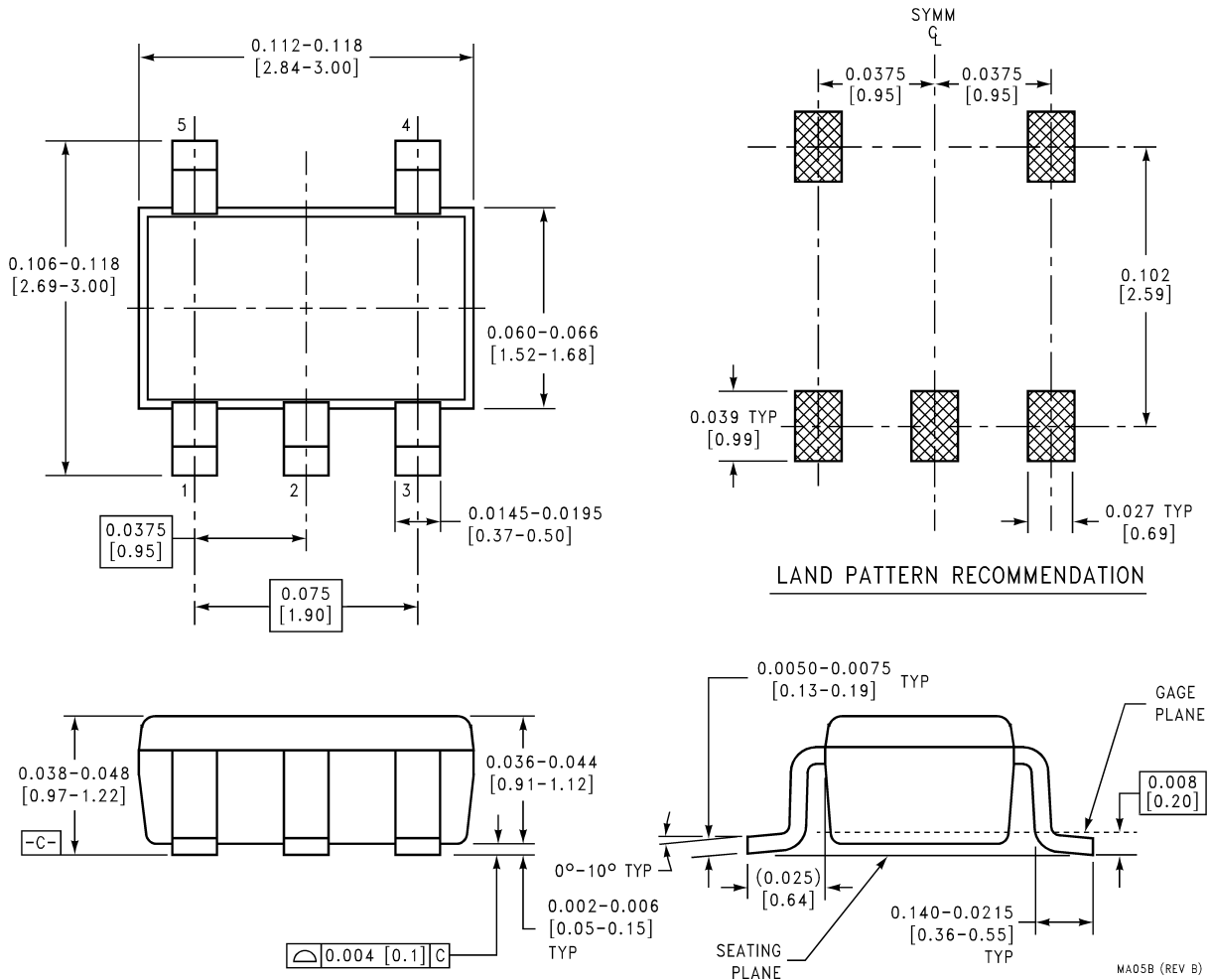

5-Lead Small Outline Package (M5)

NS Package Number MF05A

For Order Numbers, refer to *Table 1* in the "Ordering Information" section of this document.

MA05B (REV B)

Physical Dimensions inches (millimeters) unless otherwise noted (Continued)

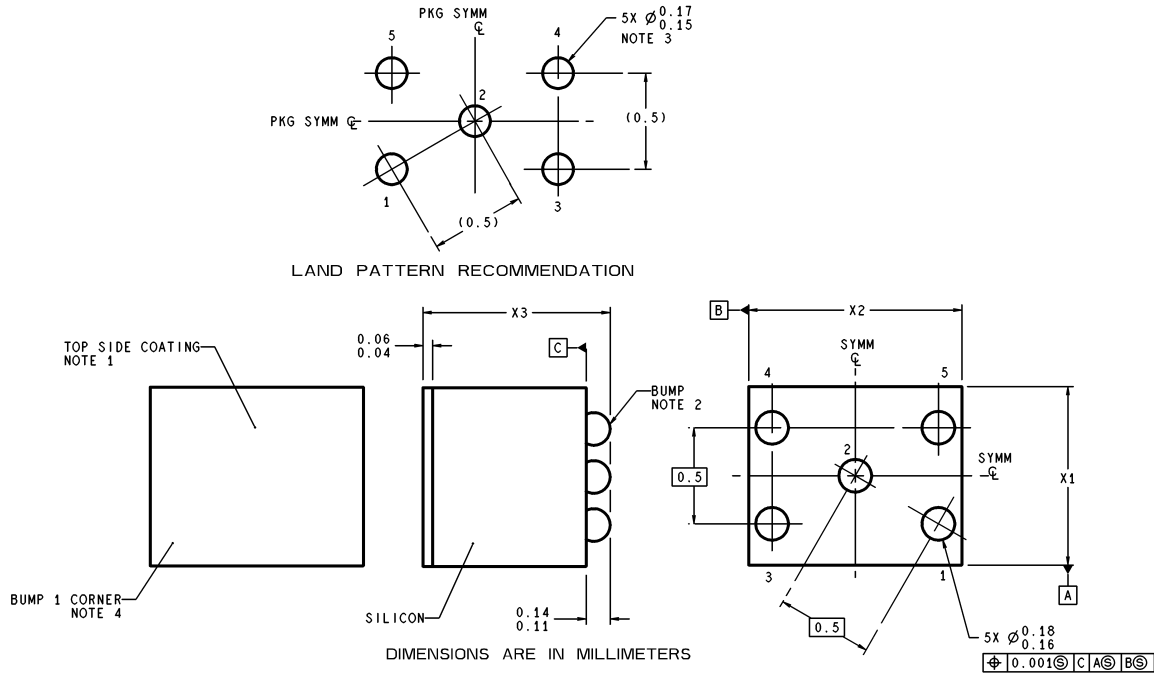

BPA05XXX (Rev A)

NOTES: UNLESS OTHERWISE SPECIFIED

1. EPOXY COATING
2. 63Sn/37Pb EUTECTIC BUMP
3. RECOMMEND NON-SOLDER MASK DEFINED LANDING PAD.
4. PIN 1 IS ESTABLISHED BY LOWER LEFT CORNER WITH RESPECT TO TEXT ORIENTATION. REMAINING PINS ARE NUMBERED COUNTER CLOCKWISE.
5. XXX IN DRAWING NUMBER REPRESENTS PACKAGE SIZE VARIATION WHERE X1 IS PACKAGE WIDTH, X2 IS PACKAGE LENGTH AND X3 IS PACKAGE HEIGHT.
6. NO JEDEC REGISTRATION AS OF AUG.1999.

micro SMD, 5 Bump Package (BPA05)

NS Package Number BPA05A

For Order Numbers, refer to *Table 1* in the "Order Information" section of this document.

The dimensions for X1, X2 and X3 are as given:

- X1 = 0.930 +/- 0.030mm
- X2 = 1.107 +/- 0.030mm
- X3 = 0.850 +/- 0.050mm

Notes

LIFE SUPPORT POLICY

NATIONAL'S PRODUCTS ARE NOT AUTHORIZED FOR USE AS CRITICAL COMPONENTS IN LIFE SUPPORT DEVICES OR SYSTEMS WITHOUT THE EXPRESS WRITTEN APPROVAL OF THE PRESIDENT AND GENERAL COUNSEL OF NATIONAL SEMICONDUCTOR CORPORATION. As used herein:

1. Life support devices or systems are devices or systems which, (a) are intended for surgical implant into the body, or (b) support or sustain life, and whose failure to perform when properly used in accordance with instructions for use provided in the labeling, can be reasonably expected to result in a significant injury to the user.
2. A critical component is any component of a life support device or system whose failure to perform can be reasonably expected to cause the failure of the life support device or system, or to affect its safety or effectiveness.



National Semiconductor Corporation
Americas
Tel: 1-800-272-9959
Fax: 1-800-737-7018
Email: support@nsc.com
www.national.com

National Semiconductor Europe
Fax: +49 (0) 180-530 85 86
Email: europe.support@nsc.com
Deutsch Tel: +49 (0) 69 9508 6208
English Tel: +44 (0) 870 24 0 2171
Français Tel: +33 (0) 1 41 91 8790

National Semiconductor Asia Pacific Customer Response Group
Tel: 65-2544466
Fax: 65-2504466
Email: ap.support@nsc.com

National Semiconductor Japan Ltd.
Tel: 81-3-5639-7560
Fax: 81-3-5639-7507