

High Voltage Transistor

NPN Silicon

MPSA44

Motorola Preferred Device

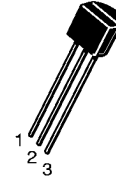
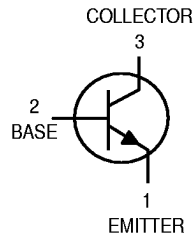

CASE 29-04, STYLE 1
TO-92 (TO-226AA)

MAXIMUM RATINGS

Rating	Symbol	Value	Unit
Collector–Emitter Voltage	V_{CEO}	400	Vdc
Collector–Base Voltage	V_{CBO}	500	Vdc
Emitter–Base Voltage	V_{EBO}	6.0	Vdc
Collector Current — Continuous	I_C	300	mA _{dc}
Total Device Dissipation @ $T_A = 25^\circ\text{C}$ Derate above 25°C	P_D	625 5.0	mW mW/ $^\circ\text{C}$
Total Device Dissipation @ $T_C = 25^\circ\text{C}$ Derate above 25°C	P_D	1.5 12	Watts mW/ $^\circ\text{C}$
Operating and Storage Junction Temperature Range	T_J, T_{stg}	-55 to +150	$^\circ\text{C}$

THERMAL CHARACTERISTICS

Characteristic	Symbol	Max	Unit
Thermal Resistance, Junction to Ambient	$R_{\theta JA}$	200	$^\circ\text{C}/\text{W}$
Thermal Resistance, Junction to Case	$R_{\theta JC}$	83.3	$^\circ\text{C}/\text{W}$

ELECTRICAL CHARACTERISTICS ($T_A = 25^\circ\text{C}$ unless otherwise noted)

Characteristic	Symbol	Min	Max	Unit
----------------	--------	-----	-----	------

OFF CHARACTERISTICS

Collector–Emitter Breakdown Voltage ⁽¹⁾ ($I_C = 1.0 \text{ mA}_{dc}, I_B = 0$)	$V_{(BR)CEO}$	400	—	Vdc
Collector–Emitter Breakdown Voltage ($I_C = 100 \mu\text{A}_{dc}, V_{BE} = 0$)	$V_{(BR)CES}$	500	—	Vdc
Collector–Base Breakdown Voltage ($I_C = 100 \mu\text{A}_{dc}, I_E = 0$)	$V_{(BR)CBO}$	500	—	Vdc
Emitter–Base Breakdown Voltage ($I_E = 10 \mu\text{A}_{dc}, I_C = 0$)	$V_{(BR)EBO}$	6.0	—	Vdc
Collector Cutoff Current ($V_{CB} = 400 \text{ Vdc}, I_E = 0$)	I_{CBO}	—	0.1	μA_{dc}
Collector Cutoff Current ($V_{CE} = 400 \text{ Vdc}, V_{BE} = 0$)	I_{CES}	—	500	nA _{dc}
Emitter Cutoff Current ($V_{EB} = 4.0 \text{ Vdc}, I_C = 0$)	I_{EBO}	—	0.1	μA_{dc}

1. Pulse Test: Pulse Width $\leq 300 \mu\text{s}$, Duty Cycle $\leq 2.0\%$.

Preferred devices are Motorola recommended choices for future use and best overall value.

MPSA44**ELECTRICAL CHARACTERISTICS** ($T_A = 25^\circ\text{C}$ unless otherwise noted) (Continued)

Characteristic	Symbol	Min	Max	Unit
ON CHARACTERISTICS(1)				
DC Current Gain ⁽¹⁾ ($I_C = 1.0 \text{ mA}$, $V_{CE} = 10 \text{ Vdc}$) ($I_C = 10 \text{ mA}$, $V_{CE} = 10 \text{ Vdc}$) ($I_C = 50 \text{ mA}$, $V_{CE} = 10 \text{ Vdc}$) ($I_C = 100 \text{ mA}$, $V_{CE} = 10 \text{ Vdc}$)	h_{FE}	40 50 45 40	— 200 — —	—
Collector–Emitter Saturation Voltage ⁽¹⁾ ($I_C = 1.0 \text{ mA}$, $I_B = 0.1 \text{ mA}$) ($I_C = 10 \text{ mA}$, $I_B = 1.0 \text{ mA}$) ($I_C = 50 \text{ mA}$, $I_B = 5.0 \text{ mA}$)	$V_{CE(sat)}$	— — —	0.4 0.5 0.75	Vdc
Base–Emitter Saturation Voltage ($I_C = 10 \text{ mA}$, $I_B = 1.0 \text{ mA}$)	$V_{BE(sat)}$	—	0.75	Vdc

SMALL–SIGNAL CHARACTERISTICS

Output Capacitance ($V_{CB} = 20 \text{ Vdc}$, $I_E = 0$, $f = 1.0 \text{ MHz}$)	C_{obo}	—	7.0	pF
Input Capacitance ($V_{EB} = 0.5 \text{ Vdc}$, $I_C = 0$, $f = 1.0 \text{ MHz}$)	C_{ibo}	—	130	pF
Small–Signal Current Gain ($I_C = 10 \text{ mA}$, $V_{CE} = 10 \text{ Vdc}$, $f = 20 \text{ MHz}$)	h_{fe}	1.0	—	—

1. Pulse Test: Pulse Width $\leq 300 \mu\text{s}$, Duty Cycle $\leq 2.0\%$.

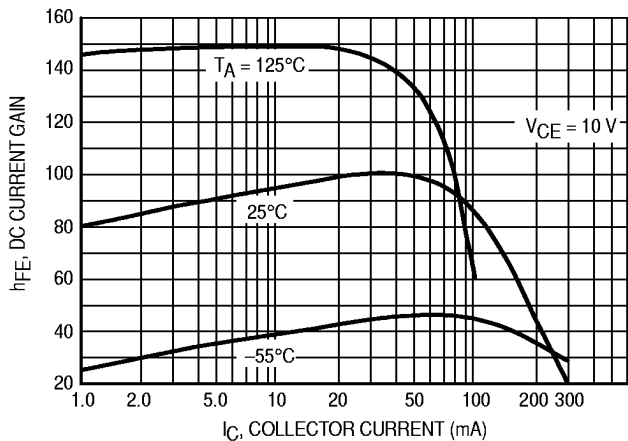

Figure 1. DC Current Gain

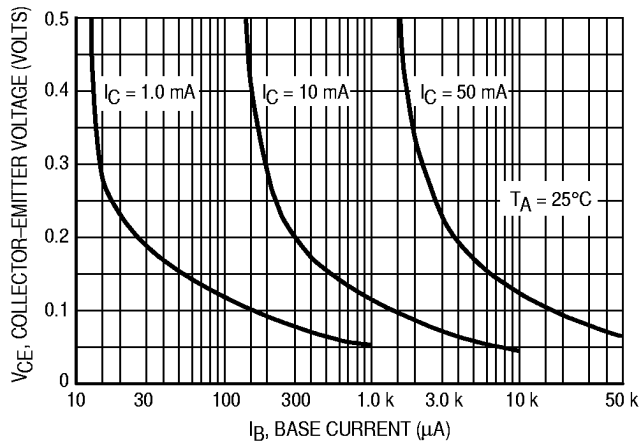

Figure 2. Collector Saturation Region

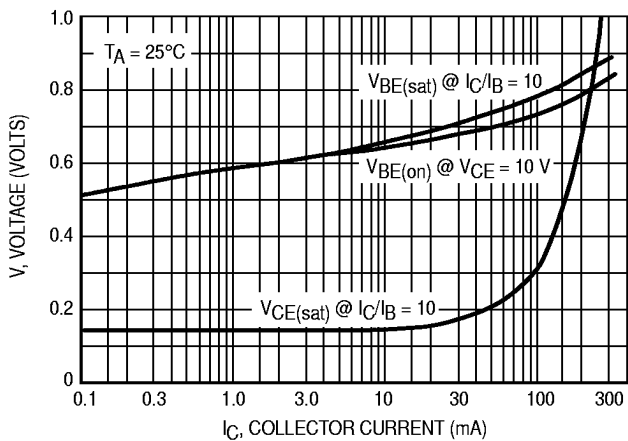

Figure 3. "On" Voltages

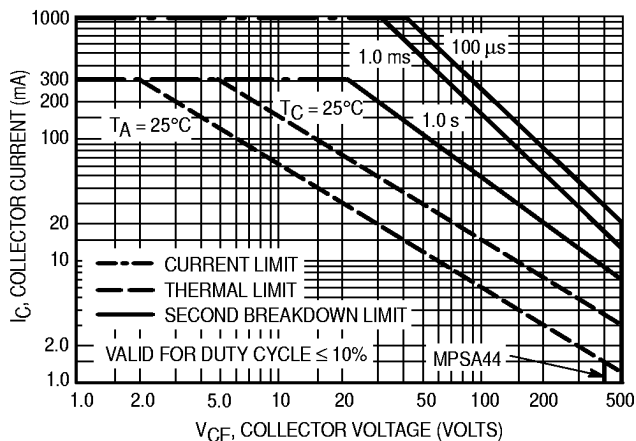

Figure 4. Active Region — Safe Operating Area

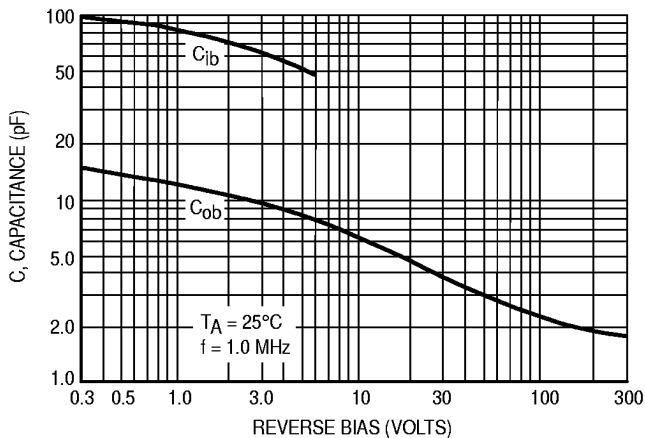

Figure 5. Capacitance

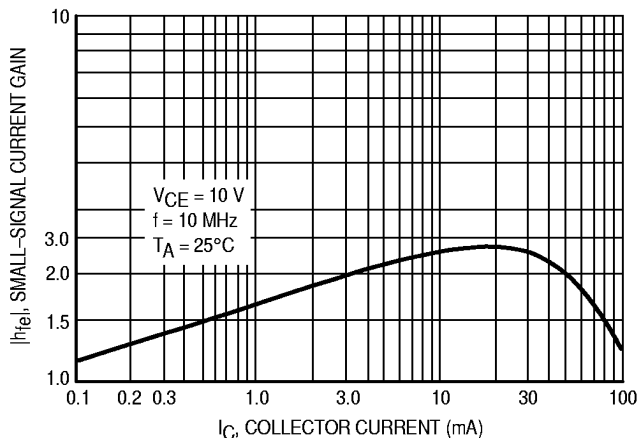

Figure 6. High Frequency Current Gain

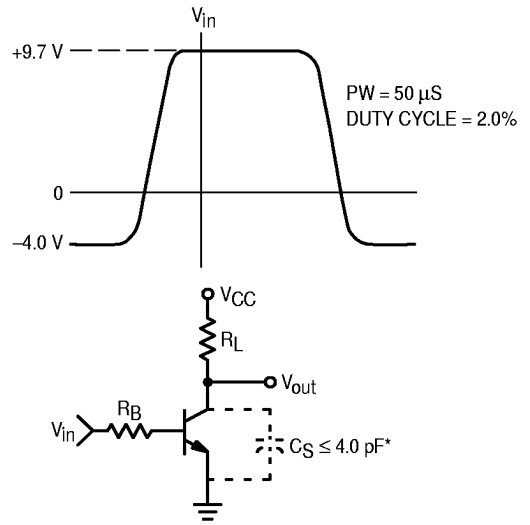
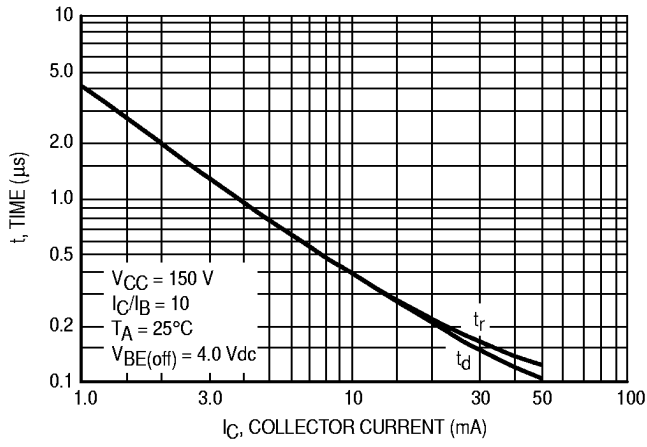

Figure 7. Turn-On Switching Times and Test Circuit

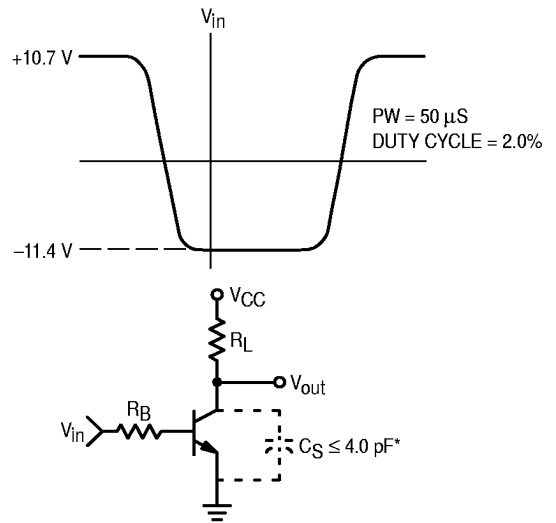
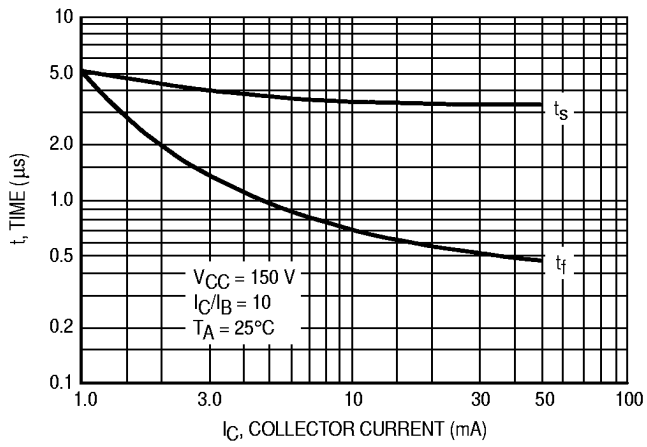
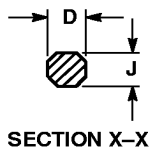
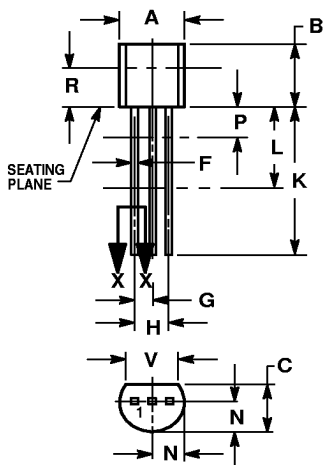

Figure 8. Turn-Off Switching Times and Test Circuit

* Total Shunt Capacitance of Test Jig and Connectors.

PACKAGE DIMENSIONS



- NOTES:
1. DIMENSIONING AND TOLERANCING PER ANSI Y14.5M, 1982.
 2. CONTROLLING DIMENSION: INCH.
 3. CONTOUR OF PACKAGE BEYOND DIMENSION R IS UNCONTROLLED.
 4. DIMENSION F APPLIES BETWEEN P AND L. DIMENSION D AND J APPLY BETWEEN L AND K. MINIMUM LEAD DIMENSION IS UNCONTROLLED IN P AND BEYOND DIMENSION K MINIMUM.

DIM	INCHES		MILLIMETERS	
	MIN	MAX	MIN	MAX
A	0.175	0.205	4.45	5.20
B	0.170	0.210	4.32	5.33
C	0.125	0.165	3.18	4.19
D	0.016	0.022	0.41	0.55
F	0.016	0.019	0.41	0.48
G	0.045	0.055	1.15	1.39
H	0.095	0.105	2.42	2.66
J	0.015	0.020	0.39	0.50
K	0.500	—	12.70	—
L	0.250	—	6.35	—
N	0.080	0.105	2.04	2.66
P	—	0.100	—	2.54
R	0.115	—	2.93	—
V	0.135	—	3.43	—

CASE 029-04
(TO-226AA)
ISSUE AD

STYLE 1:
PIN 1. EMITTER
2. BASE
3. COLLECTOR