

KA3S0880RF

SPS

SPS

The SPS product family is specially designed for an off line SMPS with minimal external component. The SPS consist of high voltage Power SenseFET and current mode control IC. Included control IC features a tr-
 - trimmed oscillator, under voltage lock out, leading edge blanking, optimized gate driver, and temperature compensated current sources. Also included are various protective functions, thermal shutdown, Over-voltage protection, Overcurrent protection, and overload protection. Compared with RCC or control IC and MOSFET solution, SPS can reduce total number of components, design size, weight. For this reason SPS can increase efficiency, productivity and system reliability. It has a basic platform well suited for cost effective C-TV power supply.

FEATURES

- Wide operating frequency range up to 150KHz
- Pulse by pulse over current limiting
- Over load protection
- Over voltage protection (min:23V)
- Internal thermal shutdown function
- Under voltage lockout
- Internal high voltage sense FET
- External sync terminal
- Auto Restart Mode

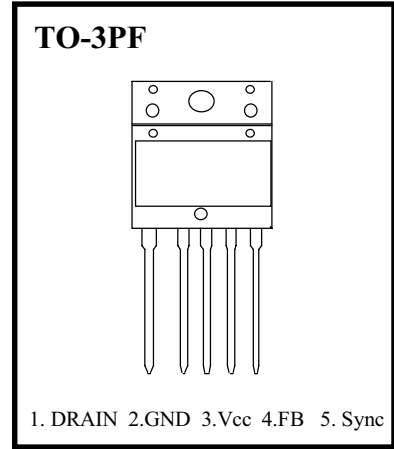

ORDERING INFORMATION

Device	Package	Rating	Topr (°C)
KA3S0880RF	TO3PF-5L	800V, 8A	-20 ~ +80

BLOCK DIAGRAM

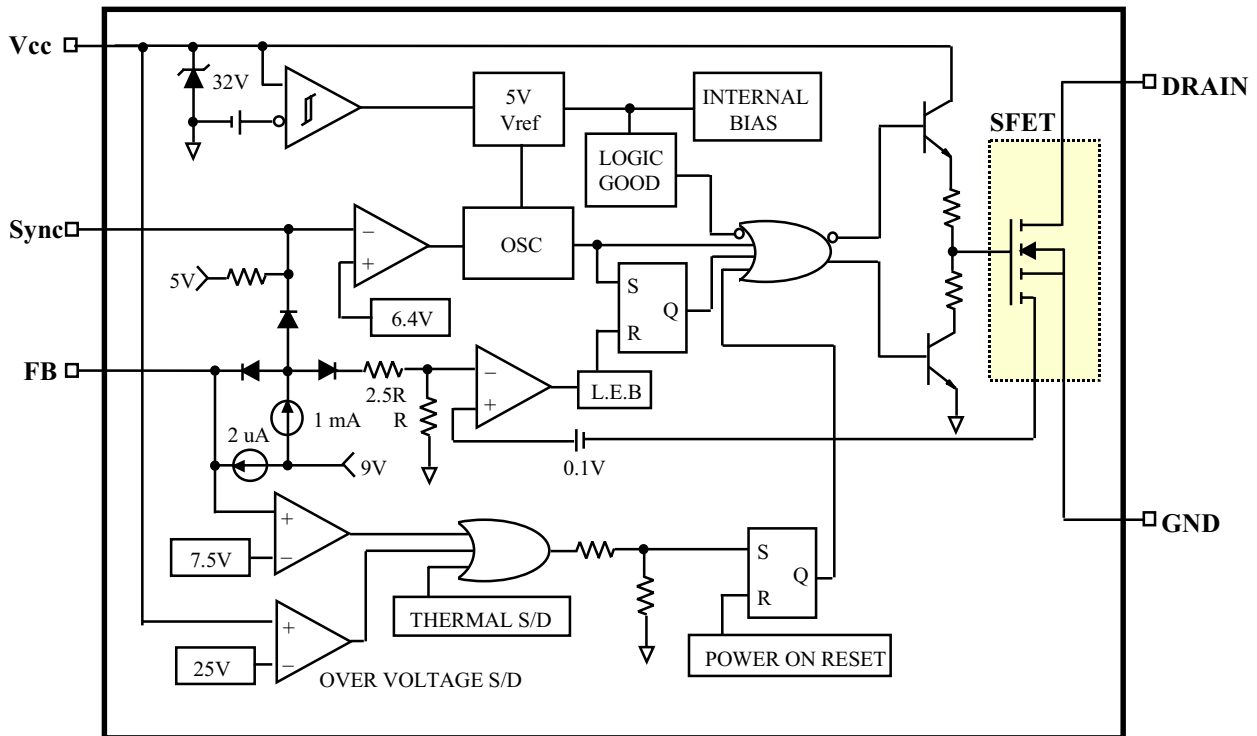

ABSOLUTE MAXIMUM RATINGS

Characteristic	Symbol	Value	Unit
Drain - Source(GND) Voltage (1)	V _{DSS}	800	V
Drain - Gate Voltage (R _{GS} = 1M Ω)	V _{DGR}	800	V
Gate - Source(GND) Voltage	V _{GS}	± 30	V
Drain Current Pulsed (2)	I _{DM}	32.0	A _{DC}
Single Pulsed Avalanche Energy (3)	E _{AS}	810	mJ
Avalanche Current	I _{AS}	-	A
Continuous Drain Current (T _c = 25 °C)	I _D	8.0	A _{DC}
Continuous Drain Current (T _c = 100 °C)	I _D	5.6	A _{DC}
Supply Voltage	V _{CC}	30	V
Analog Input Voltage Range	V _{FB}	-0.3 ~ V _{SD}	V
Total Power Dissipation	P _D (wt H/S)	190	W
	Derating	1.54	W/°C
Operating Temperature	T _{OPR}	- 25 ~ + 85	°C
Storage Temperature	T _{STG}	- 55 ~ + 150	°C

Notes: (1) T_J = 25 °C to 150 °C

(2) Repetitive rating : Pulse width limited by maximum junction temperature

(3) L = 24mH, V_{DD} = 50V, R_G = 25 Ω , starting T_j = 25 °C

ELECTRICAL CHARACTERISTICS (SFET part)

(T_a = 25 °C unless otherwise specified)

Symbol	Characteristic	Min	Typ	Max	Units	Test Conditions
BV _{DSS}	Drain-Source Breakdown Voltage	800	-	-	V	V _{GS} =0V, I _D =50uA
I _{DSS}	Zero Gate Voltage Drain Current	-	-	50	uA	V _{DS} =Max, Rating, V _{GS} =0V
		-	-	200	uA	V _{DS} =0.8Max, Rating, V _{GS} =0V TC=125 °C
R _{DS(on)}	Static Drain-Source On Resistance(4)	-	1.2	1.5	Ω	V _{GS} = 10V, I _D = 5.0A

ELECTRICAL CHARACTERISTICS (SFET part continued)

(Ta = 25 °C unless otherwise specified)

Symbol	Characteristic	Min	Typ	Max	Units	Test Conditions
g_{fs}	Forward Transconductance(4)	1.5	2.5	-	mho	$V_{DS}=15V, I_D=5.0A$
C_{iss}	Input Capacitance	-	2460	-	pF	$V_{GS} = 0V, V_{DS} = 25V,$ $f = 1MHz$
C_{oss}	Output Capacitance	-	210	-		
C_{rss}	Reverse Transfer Capacitance	-	64	-		
$t_{d(on)}$	Turn On Delay Time	-	-	90	nS	$V_{DD} = 0.5BV_{DSS}, I_D = 8.0A$ (MOSFET switching time are essentially independent of operating temperature)
t_r	Rise Time	-	95	200		
$t_{d(off)}$	Turn Off Delay Time	-	150	450		
t_f	Fall Time	-	60	150		
Q_g	Total Gate Charge (Gate-Source + Gate-Drain)	-	-	150	nC	$V_{GS} = 10V, I_D = 8.0A$ $V_{DS} = 0.5BV_{DSS}$ (MOSFET switching time are essentially independent of operating temperature)
Q_{gs}	Gate-Source Charge	-	20	-		
Q_{gd}	Gate-Drain(Miller) Charge	-	70	-		

Notes: (1) $T_J = 25\text{ }^\circ\text{C}$ to $150\text{ }^\circ\text{C}$

(2) Repetitive rating : Pulse width limited by maximum junction temperature

(3) $L = 24mH, V_{DD} = 50V, R_G = 25\ \Omega$, starting $T_J = 25\text{ }^\circ\text{C}$ (4) Pulse Test : Pulse width $\leq 300\mu\text{s}$, Duty Cycle $\leq 2\%$

ELECTRICAL CHARACTERISTICS (Control part)

(Ta = 25°C unless otherwise specified)

Symbol	Characteristics	Min	Typ	Max	Unit	Test Conditions
REFERENCE SECTION						
Vref	Output Voltage (Note 1)	4.80	5.00	5.20	V	Ta = 25°C
Vref/ ΔT	Temperature Stability (Note 1&2)	-	0.3	0.6	mV/°C	-25°C ≤ Ta ≤ +85°C
OSCILLATOR SECTION						
FOSC	Initial Accuracy	18	20	22	KHz	Ta = 25°C
ΔF / ΔT	Frequency Change with Temperature (Note 2)		±5	±10	%	-25°C ≤ Ta ≤ +85°C
VSYTH	Sync Threshold Voltage	6.0	6.4	6.8	V	Vfb = 5 V
DMAX SECTION						
DMAX	Maximum Duty Cycle	92	95	98	%	
FEEDBACK SECTION						
IFB	Feedback Source Current	0.7	0.9	1.1	mA	Ta = 25°C, Vfb = GND
Idelay	Shutdown Delay Current	1.4	1.8	2.2	uA	Ta = 25°C, 5 V ≤ Vfb ≤ VSD
OVER CURRENT PROTECTION SECTION						
IL(MAX)	Over Current Protection	4.40	5.00	5.60	A	Max. Inductor Current
UVLO SECTION						
Vth(H)	Start Threshold Voltage	14	15	16	V	
Vth(L)	Minimum Operating Voltage	9	10	11	V	After turn on

ELECTRICAL CHARACTERISTICS (Continued)

(Ta = 25 °C unless otherwise specified)

Symbol	Characteristics	Min	Typ	Max	Unit	Test Conditions
TOTAL STANDBY CURRENT SECTION						
I _{ST}	Start up Current	0.1	0.3	0.55	mA	V _{CC} = 14V
I _{OPR}	Operating Supply Current (control part only)	6	12	18	mA	Ta = 25 °C,
V _Z	V _{CC} Zener Voltage	30	32.5	35	V	I _{CC} = 20mA
SHUTDOWN SECTION						
V _{SD}	Shutdown Feedback Voltage	6.9	7.5	8.1	V	
T _{SD}	Thermal Shutdown Temperature(T _j)	140	160	-	°C	(Note 1)
V _{ovp}	Over Voltage Protection	23	25	28		
SOFT START SECTION						
I _{SS}	Soft Start Current	0.8	1.0	1.2	mA	Sync&S/S = GND
V _{SS}	Soft Start Voltage	4.7	5.0	5.3	V	V _{FB} = 2V

- Notes:** (1) These parameters, although guaranteed, are not 100% tested in production
(2) These parameters, although guaranteed, are tested in EDS(wafer test) process.
(3) The amplitude of the sync. pulse is recommended to be between 2V and 3V for stable sync. function.

TYPICAL PERFORMANCE CHARACTERISTICS

(These characteristic grahps are normalized at Ta = 25 °C)

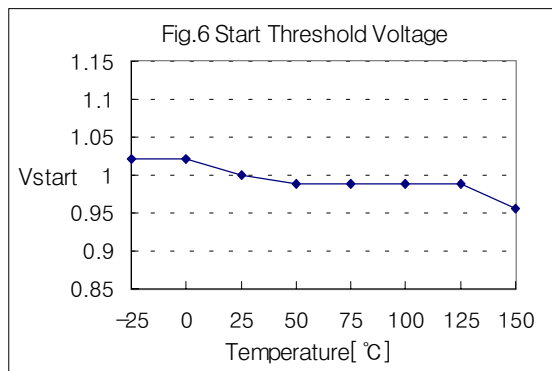
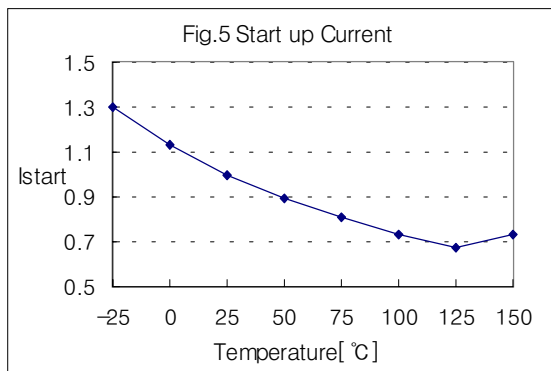
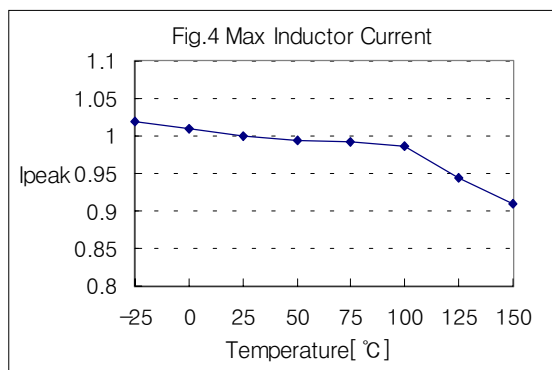
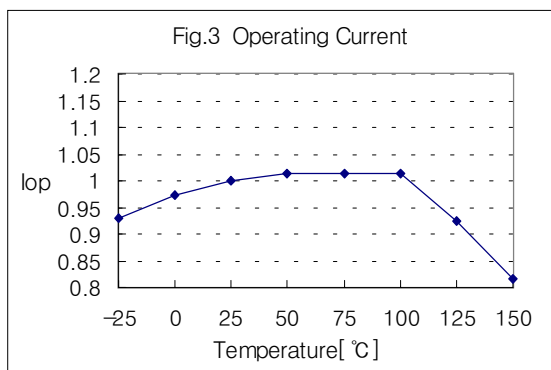
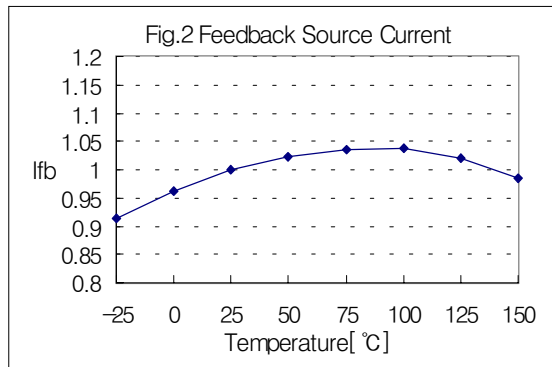
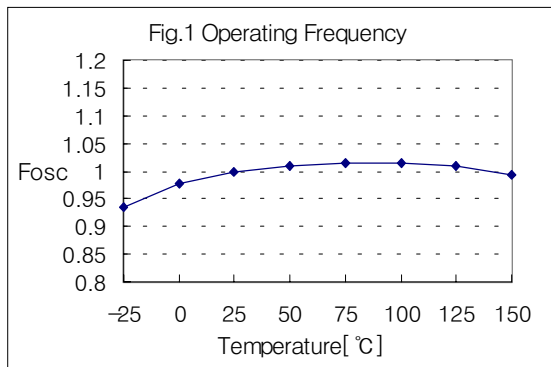

TYPICAL PERFORMANCE CHARACTERISTICS (Continued)

(These characteristic grahps are normalized at Ta = 25 °C)

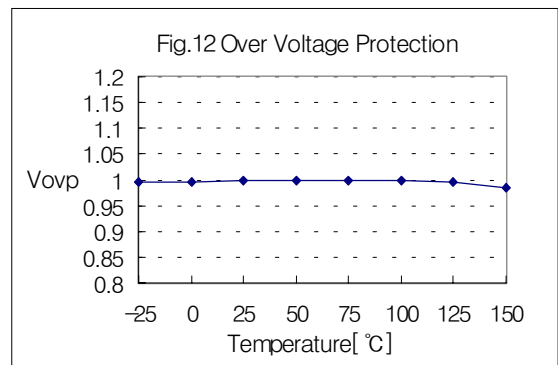
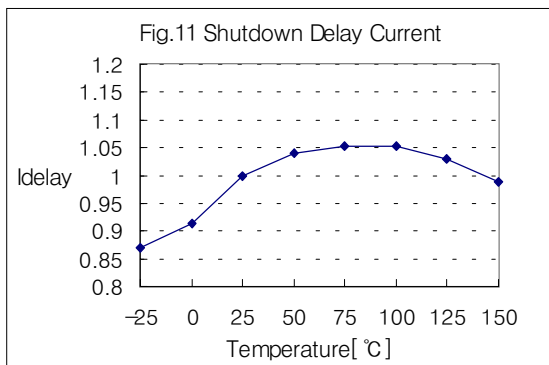
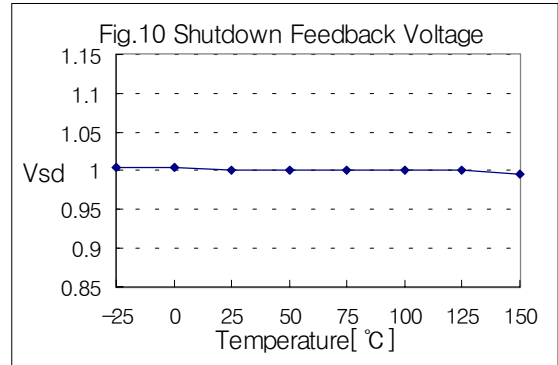
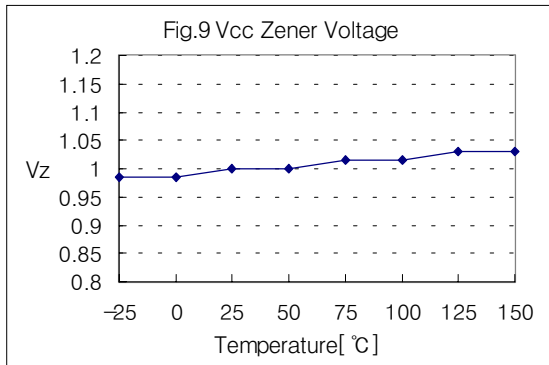
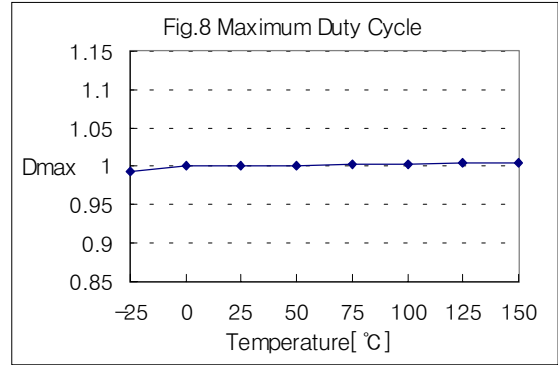
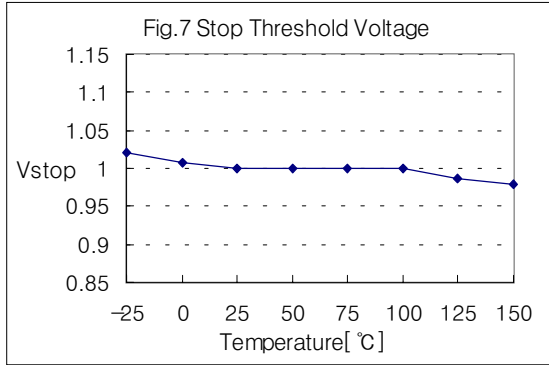

TYPICAL PERFORMANCE CHARACTERISTICS (Continued)

(These characteristic grahps are normalized at Ta = 25 °C)

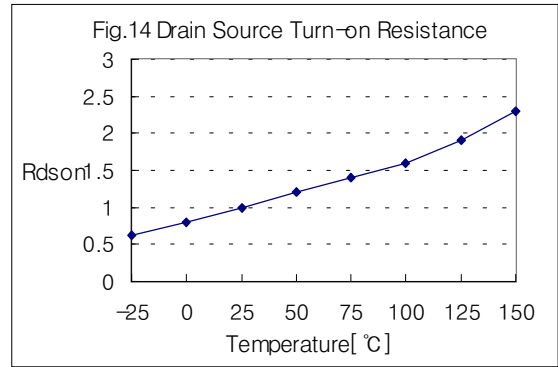
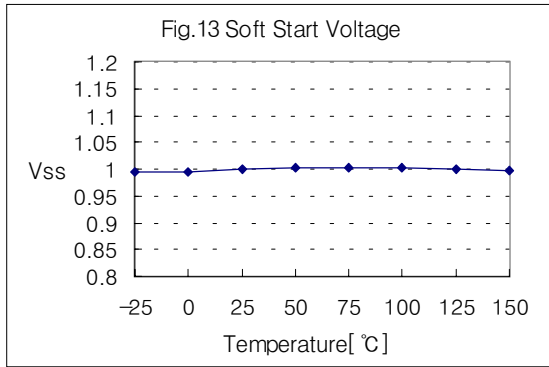

TRADEMARKS

The following are registered and unregistered trademarks Fairchild Semiconductor owns or is authorized to use and is not intended to be an exhaustive list of all such trademarks.

ACEx™	ISOPLANAR™	UHC™
CoolFET™	MICROWIRE™	VCX™
CROSSVOLT™	POP™	
E ² CMOS™	PowerTrench™	
FACT™	QST™	
FACT Quiet Series™	Quiet Series™	
FAST®	SuperSOT™-3	
FASTr™	SuperSOT™-6	
GTO™	SuperSOT™-8	
HiSeC™	TinyLogic™	

DISCLAIMER

FAIRCHILD SEMICONDUCTOR RESERVES THE RIGHT TO MAKE CHANGES WITHOUT FURTHER NOTICE TO ANY PRODUCTS HEREIN TO IMPROVE RELIABILITY, FUNCTION OR DESIGN. FAIRCHILD DOES NOT ASSUME ANY LIABILITY ARISING OUT OF THE APPLICATION OR USE OF ANY PRODUCT OR CIRCUIT DESCRIBED HEREIN; NEITHER DOES IT CONVEY ANY LICENSE UNDER ITS PATENT RIGHTS, NOR THE RIGHTS OF OTHERS.

LIFE SUPPORT POLICY

FAIRCHILD'S PRODUCTS ARE NOT AUTHORIZED FOR USE AS CRITICAL COMPONENTS IN LIFE SUPPORT DEVICES OR SYSTEMS WITHOUT THE EXPRESS WRITTEN APPROVAL OF FAIRCHILD SEMICONDUCTOR CORPORATION. As used herein:

1. Life support devices or systems are devices or systems which, (a) are intended for surgical implant into the body, or (b) support or sustain life, or (c) whose failure to perform when properly used in accordance with instructions for use provided in the labeling, can be reasonably expected to result in significant injury to the user.
2. A critical component is any component of a life support device or system whose failure to perform can be reasonably expected to cause the failure of the life support device or system, or to affect its safety or effectiveness.

PRODUCT STATUS DEFINITIONS

Definition of Terms

Datasheet Identification	Product Status	Definition
Advance Information	Formative or In Design	This datasheet contains the design specifications for product development. Specifications may change in any manner without notice.
Preliminary	First Production	This datasheet contains preliminary data, and supplementary data will be published at a later date. Fairchild Semiconductor reserves the right to make changes at any time without notice in order to improve design.
No Identification Needed	Full Production	This datasheet contains final specifications. Fairchild Semiconductor reserves the right to make changes at any time without notice in order to improve design.
Obsolete	Not In Production	This datasheet contains specifications on a product that has been discontinued by Fairchild semiconductor. The datasheet is printed for reference information only.